

Bias Q5

User Guide V1.0

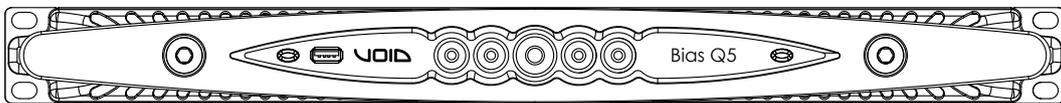

VOID

©2018 Void Acoustics Research Ltd.

Version 1.0

This user guide is subject to change without notice.
For the latest online version, visit: www.voidacoustics.com

Void Acoustics and the Void logo are registered trademarks of Void Acoustics Research Ltd. in the United Kingdom, USA and other countries; all other Void trademarks are the property of Void Acoustics Research Ltd.

Contents

1	Regulatory information	10	8	Networking	18
			8.1	IP addressing	18
2	Important safety instructions	11	8.2	Addressing troubleshooting	18
3	About	12	9	Armonía Pro Audio Suite	19
3.1	Welcome	12	9.1	Signal routing and DSP architecture	19
3.2	Unpacking and checking for shipping damage	12	9.2	Purposed workflow	19
3.3	Disposal of the packing material	12	10	Warranty and assistance	20
3.4	List of image panels	12	10.1	Warranty	20
			10.1.1	Product warranty	20
4	Installation	13	10.1.2	Return of goods	20
4.1	Location	13	10.1.3	Repair or replacement	20
4.2	Cooling	13	10.1.4	Cost and responsibility of transport	20
4.3	Cleaning	13	10.2	Assistance	20
4.4	AC mains supply	13			
4.4.1	Three-phase electric power	14	11	Appendix A: Mains wiring options	21
4.4.2	Two-phase electrical power	14	12	Appendix B: Specifications	24
4.4.3	Single-phase electric power	14			
4.5	Precautions regarding installation	14			
4.6	Switch on	14			
4.7	Switch off	15			
4.8	Mute	15			
4.9	Wi-fi switch	15			
4.10	Armonía callback	15			
5	Wi-fi	15			
6	Connections	16			
6.1	Signal grounding	16			
6.2	Analog audio input connections	16			
6.3	Digital audio input connections	16			
6.4	Output connections	16			
6.5	Ethernet connections	16			
7	LED chart	17			

A

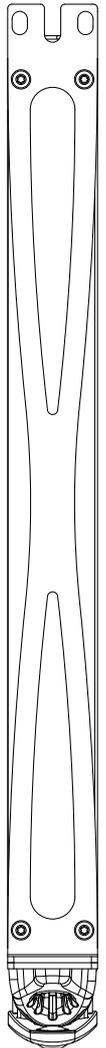
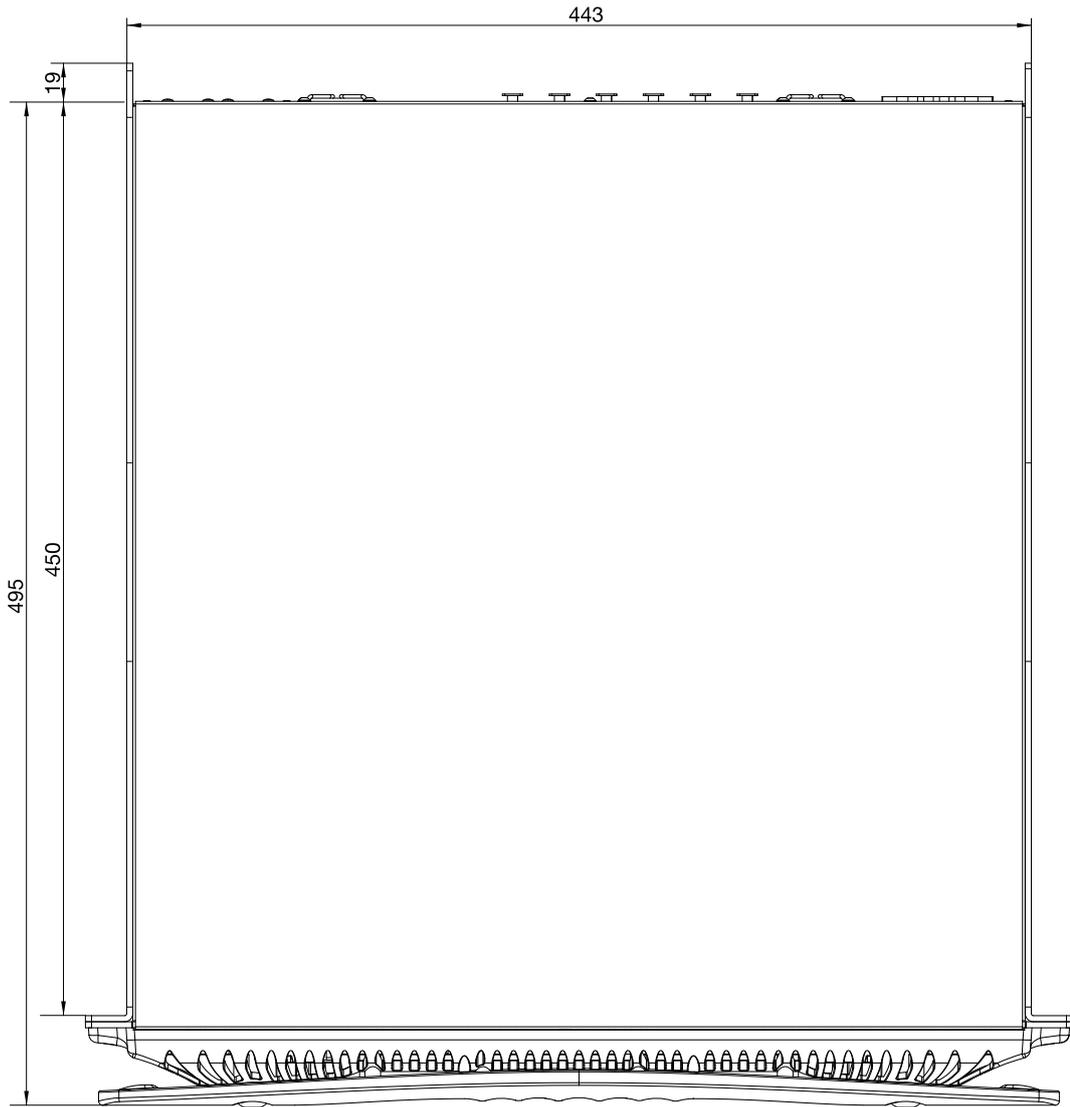
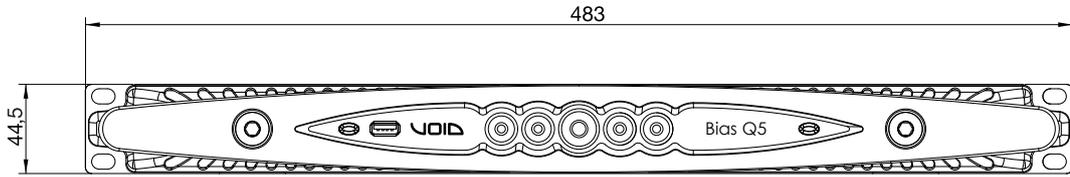

B

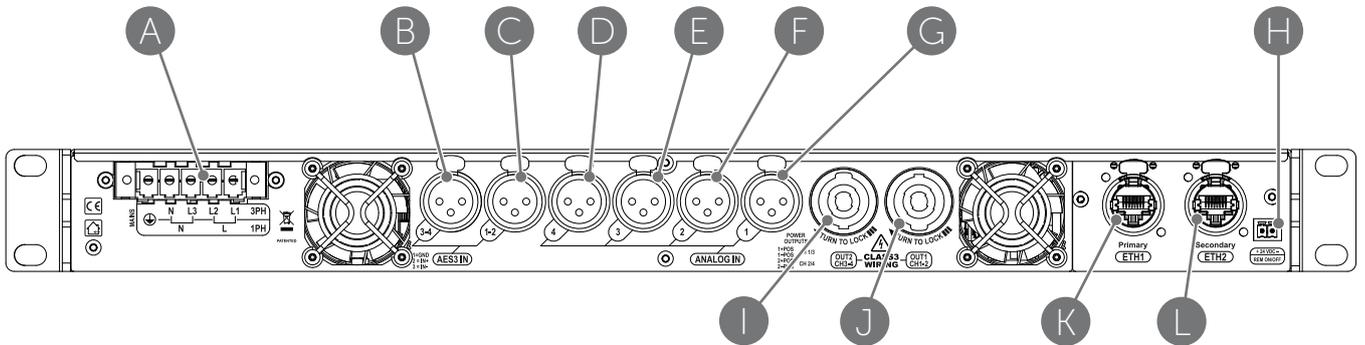

- A. AC mains Phoenix connector
- B. Input: channels 3 & 4 AES XLR
- C. Input: channels 1 & 2 AES XLR
- D. Input: channel 4 analog XLR
- E. Input: channel 3 analog XLR
- F. Input: channel 2 analog XLR

- G. Input: channel 1 analog XLR
- H. Remote ON/OFF Phoenix connector
- I. Output: channels 3 & 4 speakON
- J. Output: channels 1 & 2 speakON
- K. Ethernet: etherCON secondary port
- L. Ethernet: etherCON primary port

C

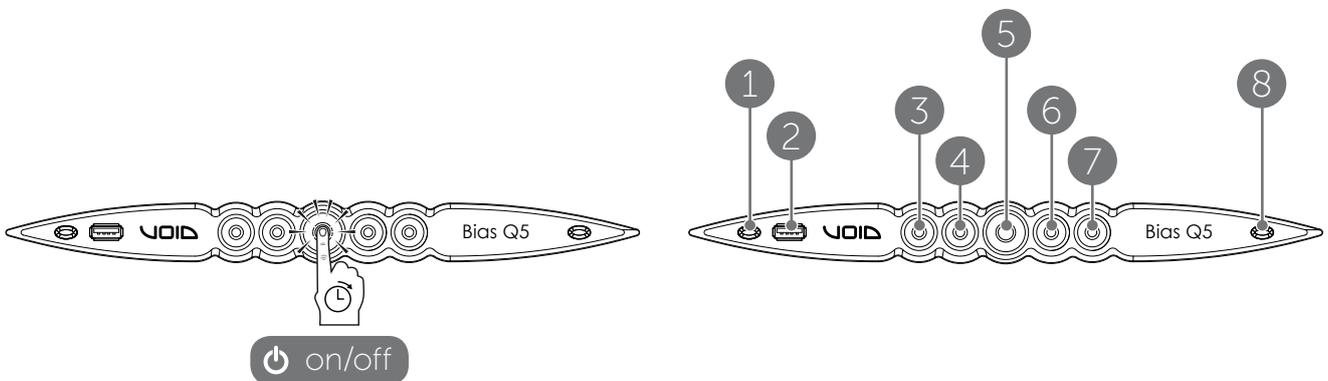

- 1. Wi-Fi on/off switch
- 2. USB port
- 3. CH1 Status LED and MUTE
- 4. CH2 Status LED and MUTE

- 5. Main on/off switch, status LED and MUTE ALL
- 6. CH3 Status LED and MUTE
- 7. CH4 Status LED and MUTE
- 8. Armonía callback

D

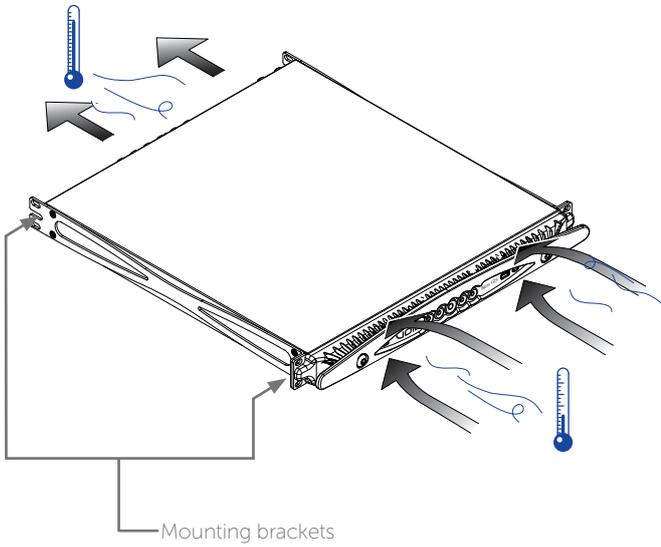

E

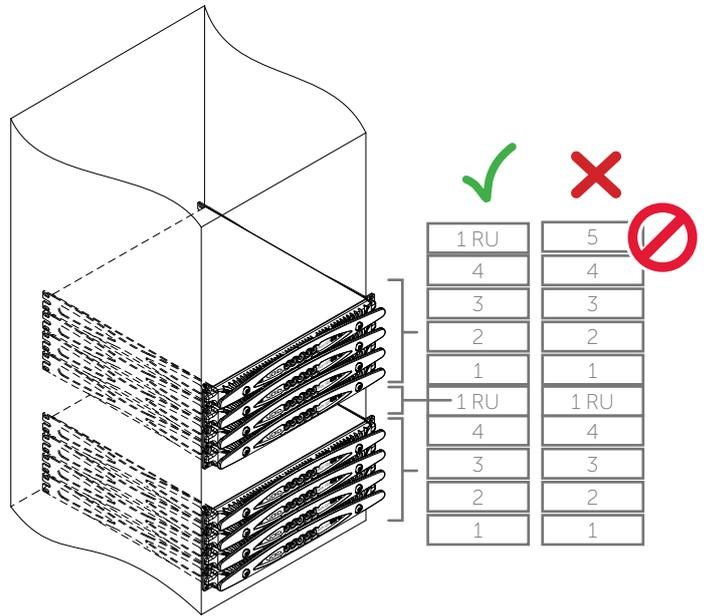

F

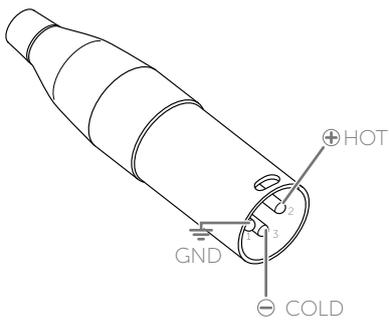

Input XLR-M pinout	
Pin 1	GND
Pin 2	HOT ⊕
Pin 3	COLD ⊖

G



Color code (TIA/EIA-568-B)	Pin
	1
	2
	3
	4
	5
	6
	7
	8

H

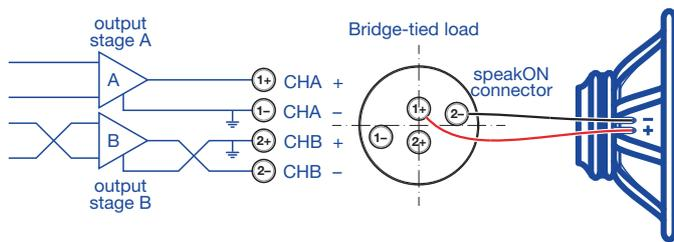
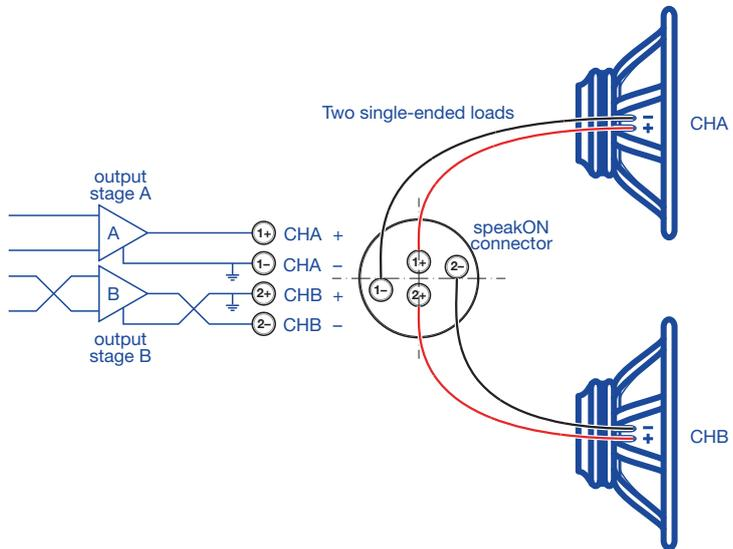

I

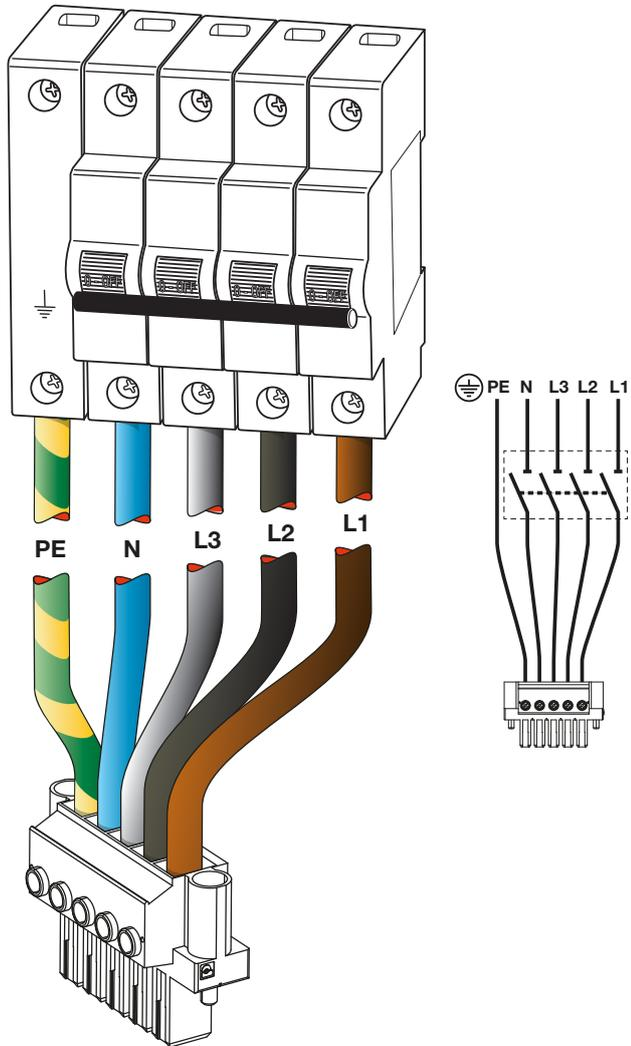
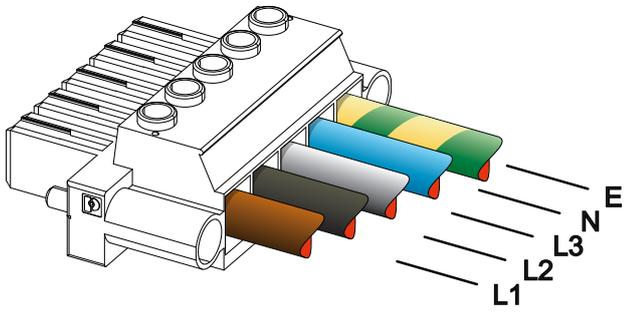

J

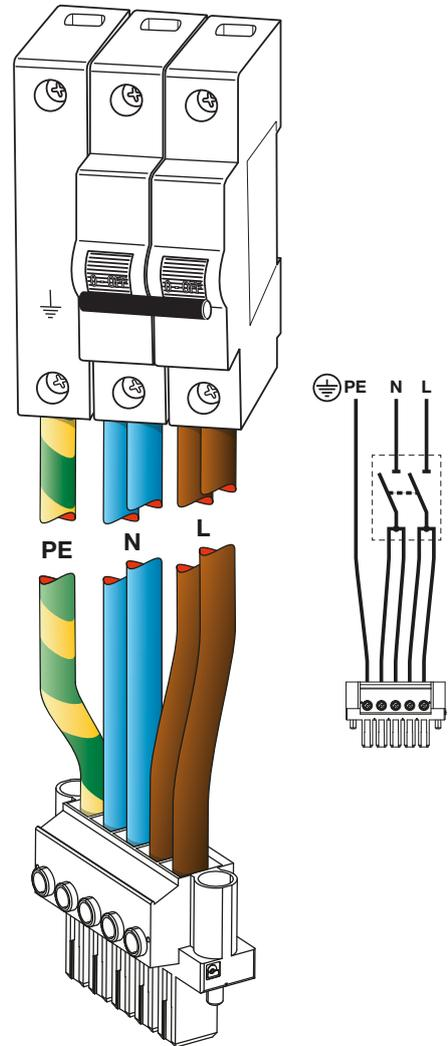
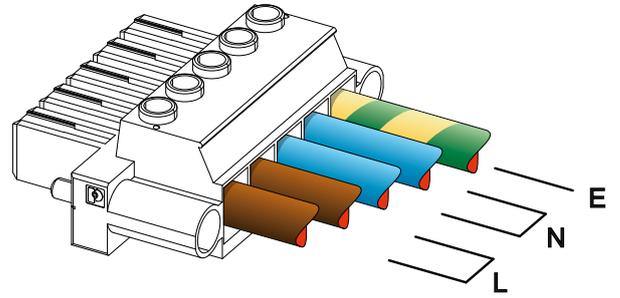

K

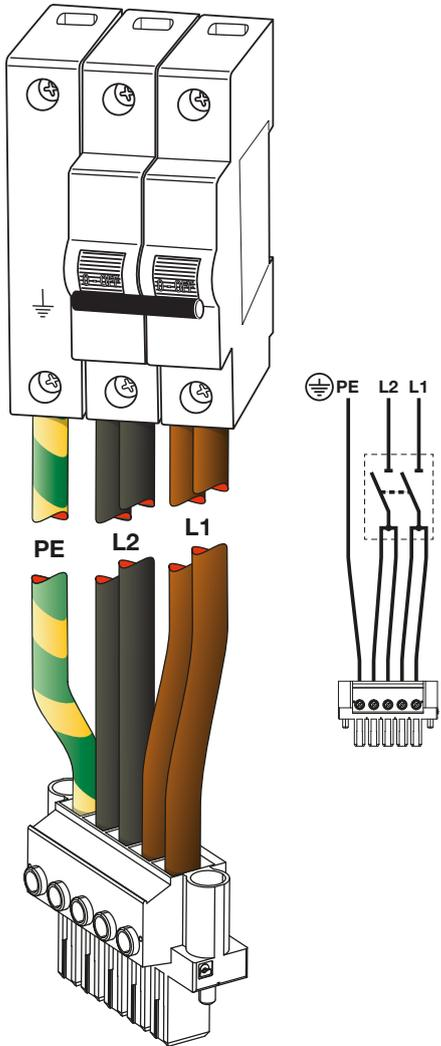
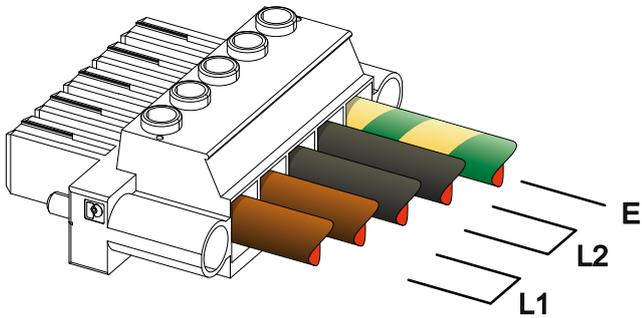

L

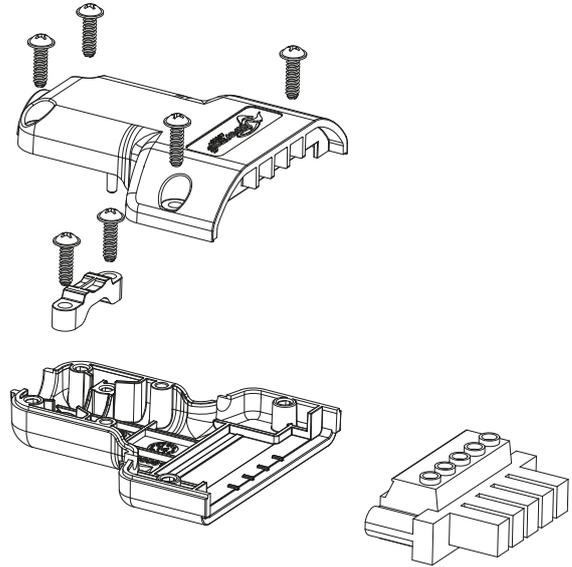

Once properly wired, insert and lock the flying connector into the shell provided by Powersoft.



1 Regulatory information

FCC COMPLIANCE NOTICE

This device complies with part 15 of the FCC rules. Operation is subject to the following two conditions: (1) This device may not cause harmful interference, and (2) this device must accept any interference received, including interference that may cause undesired operation.

CAUTION: Changes or modifications not expressly approved by the party responsible for compliance could void the user's authority to operate the equipment.

NOTE: This equipment has been tested and found to comply with the limits for a Class A digital device, pursuant to part 15 of the FCC Rules. These limits are designed to provide reasonable protection against harmful interference in a residential installation. This equipment generates, uses, and can radiate radio frequency energy and, if not installed and used in accordance with the instruction manual, may cause harmful interference to radio communications. However, there is no guarantee that interference will not occur in a particular installation. If this equipment does cause harmful interference to radio or television reception, which can be determined by turning the equipment off and on, the user is encouraged to try to correct the interference by one or more of the following measures:

- Reorient or relocate the receiving antenna.
- Increase the separation between the equipment and receiver.
- Connect the equipment into an outlet on a circuit different from that to which the receiver is connected.
- Consult the dealer or an experienced radio/TV technician for help.

WEEE DIRECTIVE

If the time arises to throw away your product, please recycle all the components possible.



This symbol indicates that when the end-user wishes to discard this product, it must be sent to separate collection facilities for recovery and recycling. By separating this product from other household-type waste, the volume of waste sent to incinerators or land-fills will be reduced and natural resources will thus be conserved.

The Waste Electrical and Electronic Equipment Directive (WEEE Directive) aims to minimise the impact of electrical and electronic goods on the environment. Void Acoustics comply with the Directive 2002/96/EC and 2003/108/EC of the European Parliament on waste electrical and electronic equipment (WEEE) in order to reduce the amount of WEEE that is being disposed of in land-fill site. All of our products are marked with the WEEE symbol; this indicates that this product must NOT be disposed of with other waste. Instead it is the user's responsibility to dispose of their waste electrical and electronic equipment by handing it over to an approved reprocessor, or by returning it to Void Acoustics for reprocessing. For more information about where you can send your waste equipment for recycling, please contact Void Acoustics or one of your local distributors.

EC DECLARATION OF CONFORMITY

Manufacturer:
Void Acoustics Research Ltd
Unit 15, Dawkins Road Ind Est.,
Poole,
Dorset, BH15 4JY,
United Kingdom



We declare that under our sole responsibility the products:
Model Names: Bias Q5
Intended use: Professional Audio Amplifier

Are in conformity with the provisions of the following EC Directives, including all amendments, and with national legislation implementing these directives:

- 2014/35/EU Low Voltage Directive
- 2014/30/EU Electromagnetic Compatibility Directive
- 2014/53/EU Radio Equipment Directive
- 2011/65/EU RoHs Directive

The following harmonised standards are applied:

- EN 55032:2012
- EN 55035:2017
- EN 55103-2:2009 /IS:2012
- EN 61000-3-3:2013
- EN 61000-3-2:2014
- EN 61065:2014 /AC:2016-4-3

For compliance questions only: info@voidacoustics.com

2 Important safety instructions

EXPLANATIONS OF GRAPHICAL SYMBOLS



The triangle with the lightning bolt is used to alert the user to the risk of electric shock.



The triangle with the exclamation point is used to alert the user to important operating or maintenance instructions.



The CE-mark indicates the compliance with the low voltage and electromagnetic compatibility.



Symbol for earth/ground connection.



Symbol indicating that the equipment is for indoor use only.



Symbol for conformity with Directive 2002/96/EC and Directive 2003/108/EC of the European Parliament on waste electrical and electronic equipment (WEEE).



Do not use the unit at altitudes above 2000 m.



Do not use the unit in tropical environment.



WARNING: TO REDUCE THE RISK OF ELECTRIC SHOCK, DO NOT ATTEMPT TO OPEN ANY PART OF THE UNIT. NO USER-SERVICEABLE PARTS INSIDE. REFER SERVICING TO QUALIFIED SERVICE PERSONNEL.



DO NOT EXPOSE THIS EQUIPMENT TO RAIN OR MOISTURE, DRIPPING OR SPLASHING LIQUIDS. OBJECTS FILLED WITH LIQUIDS, SUCH AS VASES, SHOULD NOT BE PLACED ON THIS APPARATUS.



THE UNIT MUST BE INSTALLED IN RACK CABINETS ONLY: PLUG THE AMPLIFIER'S MAINS CONNECTIONS VIA A SECTIONING BREAKER TO A POWER DISTRIBUTION PANEL INSIDE THE RACK CABINET.



THE SECTIONING BREAKER MUST REMAIN READILY ACCESSIBLE.



WHEN THE UNIT IS INSTALLED IN A RACK CABINET, MAKE SURE THAT IT HAS SUFFICIENT SPACE ON ALL SIDES TO ALLOW FOR PROPER VENTILATION (50 CM FROM THE FRONT AND REAR VENTILATION OPENINGS).



CONNECTION TO THE MAINS SHALL BE DONE ONLY BY A ELECTROTECHNICAL SKILLED PERSON ACCORDING THE NATIONAL REQUIREMENTS OF THE COUNTRIES WHERE THE UNIT IS SOLD.



**WARNING:
FUSE ON NEUTRAL**



Electrical energy can perform many useful functions. This unit has been engineered and manufactured to ensure your personal safety. But **IMPROPER USE CAN RESULT IN POTENTIAL ELECTRICAL SHOCK OR FIRE HAZARD.**

In order not to defeat the safeguards incorporated into this product, observe the following basic rules for its installation, use and service. Please read these "Important Safeguards" carefully before use.

Important safety instructions

1. Read these instructions.
2. Keep these instructions.
3. Heed all warnings.
4. Follow all instructions.
5. Do not use this equipment near water.
6. Clean only with a dry cloth.
7. Do not block any ventilation openings. Install in accordance with the manufacturer's instructions.
8. Do not install near any heat sources such as radiators, heat registers, stoves, or other apparatus (including amplifiers) that produce heat.
9. Protect the power cord from being walked on or pinched particularly at plugs, convenience receptacles, and the point where they exit from the apparatus.
10. Only use attachments/accessories specified by the manufacturer.
11. Use only with the cart, stand, tripod, bracket, or table specified by the manufacturer, or sold with the apparatus. When a cart is used, use caution when moving the cart/apparatus combination to avoid injury from tip-over.
12. Unplug this apparatus during lightning storms or when unused for long periods of time.
13. Refer all servicing to qualified service personnel. Servicing is required when the apparatus has been damaged in any way, such as power-supply cord or plug is damaged, liquid has been spilled or objects have fallen into the apparatus, the apparatus has been exposed to rain or moisture, does not operate normally, or has been dropped.



3 About

3.1 Welcome

Many thanks for purchasing this Void Acoustics Bias Q5. We truly appreciate your support. At Void, we design, manufacture and distribute advanced professional audio systems for the installed and live sound market sectors. Like all Void products, our highly skilled and experienced engineers have successfully combined pioneering technologies with groundbreaking design aesthetics, to bring you superior sound quality and visual innovation. In buying this product, you are now part of the Void family and we hope using it brings you years of satisfaction. This guide will help you both use this product safely and ensure it performs to its full capability.

3.2 Unpacking and checking for shipping damage

Your Void product has been completely tested and inspected before leaving the factory. Carefully inspect the shipping package before opening it, and then immediately inspect your new product. If you find any damage, notify the shipping company or reseller immediately.

The box contains the following:

- 1x Bias Q5 amplifier
- 1x AC mains PC 5/5-STF1-7,62 Phoenix plug
- 1x shell for the AC mains plug
- 1x quick guide.

3.3 Disposal of the packing material

The protective transport packaging has been selected from materials which are environmentally friendly for disposal and can normally be recycled.

Rather than just throwing these materials away, please ensure they are offered for recycling.

3.4 List of image panels

- A. Q5 mechanical drawings: all dimensions in millimeters
- B. Q5 rear panel
- C. Q5 front panel
- D. Mounting brackets and air flow direction
- E. Rule for stacking amplifiers in closed racks
- F. Input connector pinout
- G. RJ45 Ethernet pinout
- H. Loudspeakers wirings
- I. Three-phase electric power: AC mains plug wiring
- J. Single-phase electric power: AC mains plug wiring
- K. Two-phase electric power: AC mains plug wiring
- L. AC mains plug shield

4 Installation

4.1 Location

The intended use of Bias Q5 amplifiers is in a rack only. The AC mains wirings of the units must be connected to a terminal box provided with a properly breaker (refer to 3.4 AC mains supply for more details). It is not allowed to connect the Bias Q5 AC mains connection directly to the power distribution system. For North America market we recommend to use an approved UL/CSA cable (i.e. ST 600 Vac 105°C 5 x 13 AWG).

In order to limit the risk of mechanical damages, the amplifiers must be fixed to the rack using both frontal and rear mounting brackets. We recommends to use eight M6 or 12-24 UNC-2B screws for threaded holes or cage nuts.

Install this amplifier as far as possible from radio tuners and TV sets. An amplifier installed in close proximity of such equipment may experience noise or generic performance degradation. Placing and using the amplifier for long periods of time on heat generating sources will affect its performance. Avoid placing the amplifier on heat generating sources.

4.2 Cooling

Install the amplifier in a well-ventilated location: the ventilation openings must not be impeded by any item such as newspapers, tablecloths, curtains, etc; keep a distance of at least 50 cm from the front and rear ventilation openings of the amplifier.

All Void amplifiers implement a forced-air cooling system to maintain low and constant operating temperatures. Drawn by the internal fans, air enters from the front panel and is forced over all components, exiting at the back of the amplifier.

The amplifier's cooling system features "intelligent" variable-speed DC fans which are controlled by the heatsink temperature sensing circuits: the fans speed will increase only when the temperature detected by the sensors rises over carefully predetermined values. This ensures that fan noise and internal dust accumulation are kept to a strict minimum.

Should however the amplifier be subject to an extreme thermal load, the fan will force a very large volume of air through the heat sink. In the extremely rare event that the amplifier should dangerously overheat, sensing circuits shut down all channels until the amplifier cools down to a safe operating temperature. Normal operation is resumed automatically without the need for user intervention.

Bias Q5 amplifiers can be stacked one on top of the other due to the efficient cooling system they are equipped with.

There is however a safety limit to be observed: in case a rack with closed back panels is used, leave one rack unit empty every four installed amplifiers to guarantee adequate air flow (see Panel E, p. 6).

4.3 Cleaning

Always use a dry cloth for cleaning the chassis and the front panel. Air filter cleaning should be scheduled according to the dust levels in the amplifier's operating environment.



Disconnect the AC mains source before attempting to clean any part of the amplifier



In order to clean the vent filters you need to remove the front cover: never attempt to open any other part of the unit. By means of a metric hex key #6, unscrew the two screws located on the left and right sides of the front panel, (see figure 1) gently lift the cover and remove the filter. You may use compressed air to remove the dust from filters, or wash it with clean water: in the latter case ensure that the filter is dry before reassembly.

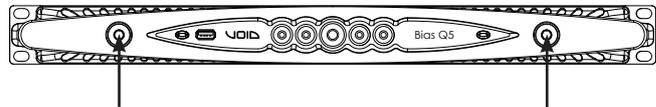

Figure 1: Use a #6 hex key to remove the front cover

4.4 AC mains supply

Bias Q5 amplifiers offers worldwide AC acceptance and direct connection to any regional power line configuration. Void's legendarily reliable power supply is now suitable to single-phase, two-phase or three-phase operation from 90 V_{AC} up to 464 V_{AC} without need of manual selection: true three-phase load balancing is directly achievable by the unit without any complex load assignment in the power distribution system design.

AC mains connection is provided by means of the euroblock Phoenix PC 5/5-STF1-7,62 flying plug (Phoenix product ID 1777862). Proper assembly of the AC mains conductors to the flying plug must respect the power line configuration. Take care to connect any and all the five contacts of the flying plug to the power cords according to the configuration showed in Panel I, J, K at p. 8 and p. 9. In order to guarantee the proper connection we recommend to use an approved UL/CSA cable (i.e. ST 600Vac 105°C 5 x 13 AWG).



This device must be powered exclusively by earth connected mains sockets in electrical networks compliant to the IEC 364 or similar rules.



Since the main power switch on this unit does not provide a complete insulation of the equipment from the main power, you must disconnect the main power source to turn off all power.

4 Installation



Provide a sectioning breaker between the mains connections and the amplifier.



The proper device to use depends on mains configuration; for Bias Q5 Void suggests:

- single-phase AC (P+N+E): 16 A rating, C or D curve, 10 kA;
- three-phase AC (3P+N+E): 4x10 A rating, C or D curve, 10 kA.

NOTE: The pictures and instructions about AC wiring refer to the European CENELEC standards April 2004 (IEC 60446) color code for conductor identification (see table 1).

Conductor		Color	
AC phase conductors	N	blue	
	L1	brown	
	L2	black	
	L3	grey	
Protective conductor (earth)		E	green/yellow

Table. 1: Color code for conductor identification.



AC mains connections must be performed only by professional or qualified personnel according to local electrical authorities guidelines.



4.4.1 Three-phase electric power

Each single conductor must be secured to the PC 5/5-STF1-7,62 flying plug as shown in Panel I, p. 8. In some instances neutral connection may lack: on three-phase systems neutral connection is not even necessary given the capability of the Bias Q5 to work in delta connection.

4.4.2 Two-phase electric power

Balanced two-phase AC mains in the configurations 2P+E without neutral must be secured to the PC 5/5-STF1-7,62 flying plug as shown in Panel K, p. 9. Take care to double the phase wires at the connecting terminals of the sectioning breaker in order to guarantee the proper conduction gauge.

4.4.3 Single-phase electric power

P+N+E, unbalanced single-phase with neutral is the usual configuration for single-phase AC mains; wiring must be configured as shown in Panel J, p. 8. Take care to double the phase and neutral wires at the connecting terminals of the sectioning breaker in order to guarantee the proper conduction gauge.

4.5 Precautions regarding installation

WARNING: TO PREVENT FIRE OR ELECTRIC SHOCK

- This device must be powered exclusively by earth connected mains sockets in electrical networks compliant to the IEC 364 or similar rules.
- Install the unit into rack cabinet only.
- A sectioning breaker between the mains connections and the amplifier must be installed inside the rack cabinet.
- Take care to properly lock each power cord wire to the flying connector Phoenix PC 5/5-STF1-7,62.
- Once properly wired, insert and lock the flying connector into the shell provided by Void.
- Lock the flying connector to the amplifier inlet.
- Before powering this amplifier, verify that the correct voltage rating is being used.
- Verify that your mains connection is capable of satisfying the power ratings of the device.
- Do not use this amplifier if the electrical power cord is frayed or broken.
- Output terminals are hazardous: wiring connection to these terminals require installation by an instructed person and the use of ready-made leads.
- Take care to lock the output terminal before switching the device on.
- To avoid electrical shock, do not touch any exposed speaker wiring while the amplifier is operating.
- Do not spill water or other liquids into or on the amplifier.
- No naked flame sources such as lighted candles should be placed on the amplifier.
- Do not remove the cover. Failing to do so will expose you to potentially dangerous voltage.
- The manufacturer cannot be held responsible for damages caused to persons, things or data due to an improper or missing ground connection.
- Contact the authorized service center for ordinary and extraordinary maintenance.

It is absolutely necessary to verify these fundamental requirement of safety and, in case of doubt, require an accurate check by qualified personnel.

4.6 Switch on

As soon as you connect the amplifier to the power grid, the amplifier's power supply will start supplying power to the auxiliary systems. The border of the central button starts blinking white: the amplifier is in standby mode.

A pressure on the central button will wake up the amplifier.



4 Installation

5 Wi-Fi

4.7 Switch off

Keep pressed the central button for 3 seconds to switch the amplifier off. The amplifier platform passes to the standby mode and the border of the central button blinks white.

The amplifier platform turns completely off only when the mains connector is unplugged.

4.8 Mute

A short pressure on the central button toggles MUTE/UNMUTE to all active channels: any previously muted channel will remain in mute status.

All other circular buttons (except the central one) toggle the MUTE/UNMUTE to the specified output channel.

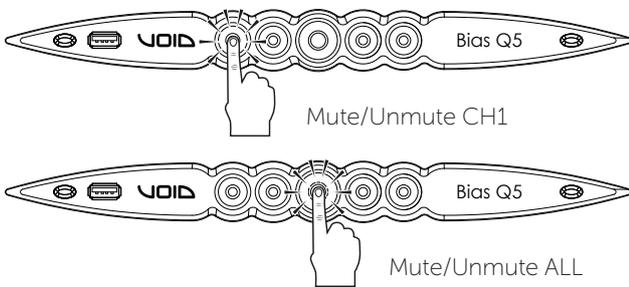

NOTE: Please note that when the amplifier platform is linked and controlled by Armonia Pro Audio Suite™ all MUTE switches are locally disabled.

4.9 Wi-Fi switch

Press the leftmost button: the button will light up and the system will establish a new local Wi-Fi network whose SSID is in the form: Void-MODELNAME-SERIAL (e.g. Void-BiasQ5-70133) and default password: 0123456789. Press again the leftmost button to switch the Wi-Fi off.

4.10 Armonia callback

In order to identify the unit into the Armonia Workspace, push on the rightmost button. On the other hand, if you click on Un/Blink from the contextual menu of the amplifier into the Armonia Workspace, all the front LEDs of the amplifier will blink for a while.

Follow this procedure to activate the Wi-Fi connection and remotely access your Void Bias Q5 amplifier platform.

1. Switch on the amplifier by holding down the central button on the front panel;
2. Press the leftmost button in the front panel: the button will light up and the system will establish a new local Wi-Fi network whose SSID is in the form:

Void-MODELNAME-SERIAL (e.g. Void-BiasQ5-71520)

3. Access your mobile device and edit the Wi-Fi configuration;
4. Hang the Wi-Fi network with the right SSID;



5. Insert the following default Wi-Fi encryption password:

0123456789

6. Open the web browser and type the following IP address in the address bar:

192.168.0.1



7. The system will push the user interface to the browser: now you can start managing your Bias Q5 amplifier platform.
8. For simple recall and operation with the interface, we suggest to bookmark the page on the home screen of your mobile device; for example, in iOS device click on the share icon and select "Add to Home Screen" when the interface has been completely loaded.
9. Remember to switch the local Wi-Fi network off when monitoring and basic setup are no more necessary: press the leftmost button in the front panel in order to switch off the Wi-Fi.

6 Connections

Make sure the power switch is off before attempting to make any input or output connections.

By using good quality input and speaker cables, the likelihood of erratic signal behavior is reduced to a minimum. Whether you make them or buy them, look for good quality wires, connectors and soldering techniques.

6.1 Signal grounding

There is no ground switch or terminal on the Bias Q5 amplifiers. All shield terminals of input connections are directly connected to the chassis. This means that the unit's signal grounding system is automatic. In order to limit hum and/or interference entering the signal path, use balanced input connections. In the interests of safety, the unit **MUST** always operate with electrical safety earth connected to the chassis via the dedicated Protective Earth  wire.

6.2 Analog audio input connections

Analog input is provided by means of Neutrik XLR female connectors, one per channel input. Signal polarity of analog input connections is shown in Panel F, p. 6.

6.3 Digital audio input connections

Digital input is supported via AES3 (AES/EBU).

AES3 connectors are Neutrik XLR female, one per channel pair. The AES3 connection carries a channel pair through a 110 Ω nominal impedance wire in the form of a balanced (differential) digital signal: in AES3 XLR connectors the identification of hot and cold pins is not an issue; take care to never tie pin 2 or pin 3 (balanced signals) to pin 1 (ground). Avoid the use of microphone cables in AES connections: impedance mismatch can result in signal reflections and jitter, causing bit errors at the receiver.

Ethernet cabling must comply to TIA/EIA-568-B and adopt the T568B scheme pinout, as shown in Panel G, p. 6.

6.4 Output connections



CLASS3 WIRING

Output terminals are hazardous: wiring connection to these terminals require installation by an instructed person and the use of ready made leads. Take care to secure the output terminals before switching the device on. Single-ended and bridge-tied loudspeakers connection are supported as shown in Panel H, p. 7.

6.5 Ethernet connections

Bias Q5 amplifier platforms can be remotely controlled via an Ethernet connection through a personal computer and Powersoft Armonia Pro Audio Suite software.

Void recommends the use of Ethernet Cat5 straight through – patch – cables with pin/pair assignments TIA/EIA-568-B, i.e. T568B, as shown in Panel G, p. 6.

7 LED chart

All circular back illuminated buttons provide status information. The CENTER of each channel button provides status information about the OUTPUT signal.

Center color OUTPUT indicators			Center color OUTPUT indicators		
color		status	color		status
	blue	Channel ready		orange	MUTE OUTPUT
	yellow	Limiter active		orange blinking	MUTE INPUT

The RING of each channel button provides status information about the INPUT signal.

Ring color INPUT indicators		
color		status
	white blinking (center blue)	Input signal presence
	red	Input signal clipping

Channel fault and Armonia callback are associated to the following LED signals.

color		status
	red blinking (center and ring)	Channel fault
	blinking / all channels (center and ring)	Unit answering to Armonia callback

The central button light on when the system is in standby mode or in case of failure in the power supply unit:

Ring color CENTRAL button		
color		status
	white pulsing (all LEDs off)	System powered Standby mode
	red pulsing (normal operating)	fan fault detected (output stage side fan)

Center color CENTRAL button		
color		status
	red blinking	power supply or PSU fan fault detected
	yellow blinking	power supply temperature protection active

8 Networking

Bias Q5 amplifier platforms support linear daisy-chain, star and loop network topologies; in a daisy-chained network the PC with Armonia Pro Audio Suite must always be at one end of the chain.

Be aware that daisy-chaining does not guarantee reliability in production environment, since any fault may yield to network sectioning and loss of system control.

8.1 IP addressing

Factory default network settings are DHCP/AutoIP, in order for the amplifier platform to self-configure when connected to an existing LAN or PC. Fixed IP policy can also be adopted and configured through Armonia Pro Audio Suite.

If a DHCP server is not active within the network, the amplifier platform initiates a stateless address auto-configuration (i.e. Zero-configuration networking methodology – Zeroconf): it self assigns a local numeric network address (of the type 169.254.x.y – 172.31.*.* for the secondary network if present – with a subnet mask 255.255.0.0) and automatically distributes and resolves the hostnames of networked devices. For setting a static IP address, please refer to the Armonia Pro Audio Suite user guide.

8.2 IP addressing troubleshooting

When connecting the Bias Q5 to a network environment it may happen that Armonia Pro Audio Suite does not discover or import the amplifier.

Usually this is a problem of IP addressing: both Armonia and the Bias Q5 must belong to the same subnet. If a DHCP server is present on the network and a Bias Q5 amplifier platform is in AUTO IP, networking may become unstable.

As a rule of thumb, turn the DHCP server on before connecting the amplifiers.

IP addressing of a Bias Q5 amplifier is established during the bootstrap: when the Bias Q5 amplifier platform discovers a DHCP server on the network during the startup, it negotiates the networking parameters. If the Bias Q5 amplifier platform does not reveal a DHCP server on the network during the startup, it set itself in AUTO IP mode.

9 Armonía Pro Audio Suite

Armonía Pro Audio Suite is the default configuring interface that allows system setting and customization of the Bias Q5 amplifier platforms.

Armonía can be installed on a PC running Windows (XP SP3 and higher). Download Armonía Pro Audio Suite from the Armonía forum:

http://www.voidacoustics.com/void_uploads/Armonia.zip

Bias Q5 amplifier platforms can connect to the PC running Armonía through a Fast Ethernet connection. In order to start remote operation, the device must be discovered and imported into the Armonía Workspace. Click on the Discover button in the Remote entities windows, or select it from the Model list and drag it into the Armonía Workspace.

The callback button – located rightmost on the front panel of the amplifier – allows you to highlight the presence of the amplifier into the Armonía Workspace.

Once connected to Armonía Pro Audio Suite, a double click on the amplifier icon in the Workspace will open the amplifier dashboard. Here it is possible to access and configure all the features of the Bias Q5 platform.



Figure 3: Armonía Pro Audio Suite.

9.1 Signal routing and DSP architecture

Signal processing on Void Bias Q5 amplifier platforms accomplishes multiple functions that affect the audio signal before power amplification. The main adjustments include gain, polarity, delay, limiting and signal equalization; some processing are related only to particular stages, such as limiting and damping control that are implemented on the output section only, or input priority assignment available in the input section.

The processing architecture is composed of six sections:

- Input source selection. The input section allows you to manage input gain and delay of analog and digital sources, in order to compensate transmission latency and levels. Furthermore, the Bias Q5 implements a backup policy aimed to improve reliability against signal fault. By assigning a bus priority to the four different input sources – analog and AES3 – per channel, the system is able to automatically switch to a reliable input connection in case of any signal fault.
- Matrix. The innovative routing engine of Bias Q5 allows any input to be routed to any output. The Matrix implements a non-Boolean routing architecture allowing free channel assignment and level adjustment.
- Advanced processing. This allows you to optimize levels and shape the sound of the input signals. Gain and polarity adjustment, asymmetric raised-cosine full parametric filters, delay and mute are available on each channel routed to the speaker section.
- Speaker equalization. Designed to manage the configuration presets for multi-way systems, it implements FIR and IIR full parametric filters.
- Speaker routing. Once properly grouped, the output channels are presented to the matrix as speakers – a single row representing a speaker (actually group of ways) – allowing a high grade of granularity in signal processing.
- Output processing. This allows fine-tuning of output signals, aiming to optimize power delivering and loudspeaker performance. It provides gain and polarity adjustment, IIR and FIR full parametric filters, delay, mute, limiting and damping control on each output channel.

9.2 Purposed workflow

Once the loudspeaker layout has been defined, we suggest a bottom-up configuration procedure that starts from the configuration of the transducers layout and raises toward the input selection and the definition of the backup policy.

Shortly, the main steps to follow are:

1. Load the loudspeaker presets or manually configure the loudspeaker layout (grouping output channels, crossovers, limiting, speaker processing, etc.).
2. Define the routing path and the levels of the signals from the input channels to the active output channels (matrix).
3. Select the signal source from the input connections and define the backup policy (input source selection).

10 Warranty and assistance

10.1 Warranty

10.1.1 Product warranty

Void guarantees its manufactured products to be free from defective components and factory workmanship for a period of 48 (forty eight) months, starting from the date of purchase printed on Void's (or any of its Authorized Dealer's) invoice to the end customer. All warranty repairs and retrofits must be performed at Void facilities or at an Authorized Service Center at no cost for the purchaser. Warranty exclusion: Void's warranty does not cover product malfunctioning or failure caused by: misuse, abuse, repair work or alterations performed by non-authorized personnel, incorrect connections, exposure to harsh weather conditions, mechanical damages (including shipping accidents), and normal wear and tear. Void will perform warranty services provided that the product is not damaged during transportation.

10.1.2 Return of goods

Goods can be returned to Void only after they have been granted a Return Merchandise Authorization (RMA) number to be attached to the external packaging. Void (or its Authorized Service Center) has the right to refuse any returned good without a RMA number.

10.1.3 Repair or replacement

Void reserves the right to repair or replace any defective goods covered by product warranty at its sole discretion and as it deems best.

10.1.4 Cost and responsibility of transport

The purchaser (or end user/customer) is solely responsible for all transportation costs and risks associated with sending warranty covered goods to Void or its Authorized Service Center. Void will assume full responsibility and cover all costs incurred to send the goods back to the purchaser (or end user/customer).

10.2 Assistance

All servicing and repairs for Void Bias series amplifiers is handled by Powersoft Worldwide. Please follow the instructions below in case of any difficulties.

There are no user-serviceable parts in your amplifier. Refer servicing to qualified technical personnel. In addition to having an in-house service department, Powersoft supports a network of authorized service centers. If your amplifier needs repair, contact your Powersoft dealer (or distributor). You can also contact the Powersoft Technical Service department to obtain the location of the nearest authorized service center.

Even though most product malfunctioning can be solved at your premises through Powersoft Customer Care or your direct knowledge, occasionally, due the nature of the failure, it might be necessary to return defective products to Powersoft for repair. In the latter case, before shipping, you are kindly asked to follow step by step the procedure described below:

- Obtain the "Defect Report Form" by contacting our Customer Care Department via email: service@powersoft.it or download the "Defect Report Form" from Powersoft's website (<http://www.powersoft-audio.com/en/support/service>).
- Fill out one "Defect Report form" for each returned item (the form is an editable tab guided document) and save as your name, amp model and serial Number (for example: `distributorenamek10sn17345.doc`) providing all required information except the RMA code/s and send it to service@powersoft.it, bryan@voidacoustics.com and marco.mannuci@powersoft.it for Powersoft approval.
- In case of defect reports approved by the Powersoft Customer Service Representative you will receive an RMA authorization code (one RMA code for each returning device).
- Upon receiving the RMA code you must package the unit and attach the RMA code outside the pack, protected in a waterproof transparent envelope so it is clearly visible.
- Once the unit has been repaired you will be provided with a works form which must be forwarded to bryan@voidacoustics.com and the customer.

All returning items must be shipped to the following address:

Powersoft
Via Enrico Conti, 13-15
50018 Scandicci (FI) Italy

In case of shipment from countries NOT belonging to the European Community make sure you have also followed the instructions described in the document available for download at the TEMPORARY EXPORTATION / IMPORTATION PROCEDURE link at

<http://www.powersoft-audio.com/en/support/service>.

Thank you for your understanding and cooperation and continued support as we work to improve our partnership.

Appendix A: Mains wiring options

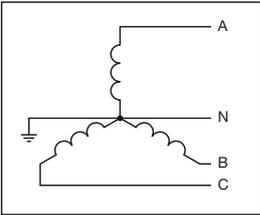
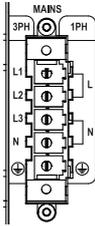
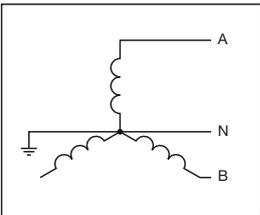
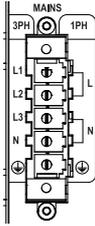
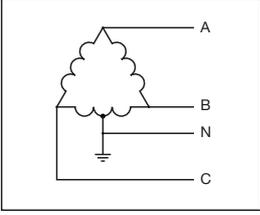
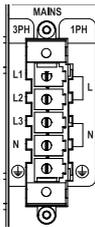
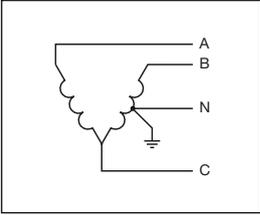
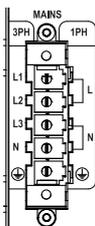
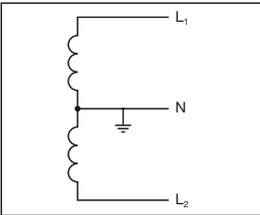
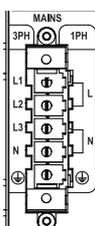
CONNECTION SYSTEM	CABLE WIRING	Q5 CONNECTOR	BREAKER CONNECTION
<p>1</p>  <p>3-Phase Wye: 4-Wire; Grounded Neutral and Contiguous Ground.</p>	<p>A - L₁ B - L₂ C - L₃ N - N ↓ - ⊕</p>		
<p>2</p>  <p>2-Phase Wye: 3-Wire; Grounded Neutral and Contiguous Ground (typically called a single phase supply in North America).</p>	<p>A - L₁ // L₂ B - L₃ // N N - n.c. ↓ - ⊕</p>		<p>Symbol "L1 // L2" (parallel connection) means connect the pole L1 together with the pole L2. The parallel connection must be done at the breaker output and not at the connector level. Symbol "n.c." means not connected.</p>
<p>3</p>  <p>3-Phase Delta: 4-Wire; Grounded at Midpoint of Phase and Contiguous Ground</p>	<p>A - L₁ B - L₂ C - L₃ N - n.c. ↓ - ⊕</p>		
<p>4</p>  <p>3-Phase Open Delta: 4-Wire; Grounded at Midpoint of Phase; Contiguous Ground</p>	<p>A - L₁ // L₂ B - L₃ // N C - n.c. N - n.c. ↓ - ⊕</p>		<p>Symbol "L1 // L2" (parallel connection) means connect the pole L1 together with the pole L2. The parallel connection must be done at the breaker output and not at the connector level. Symbol "n.c." means not connected.</p>
<p>5</p>  <p>Single-Phase: 3-Wire; Grounded Neutral; Grounded at Midpoint of Phase; Contiguous Ground</p>	<p>L₁ - L₁ // L₂ L₂ - L₃ // N N - n.c. ↓ - ⊕</p>		<p>Symbol "L1 // L2" (parallel connection) means connect the pole L1 together with the pole L2. The parallel connection must be done at the breaker output and not at the connector level. Symbol "n.c." means not connected.</p>

Appendix A: Mains wiring options

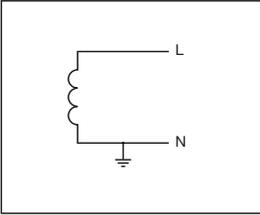
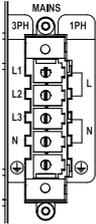
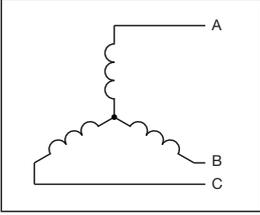
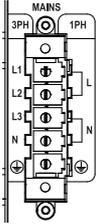
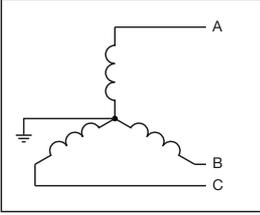
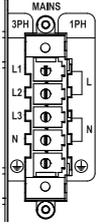
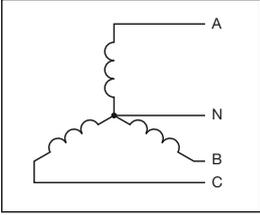
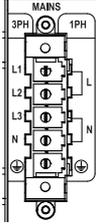
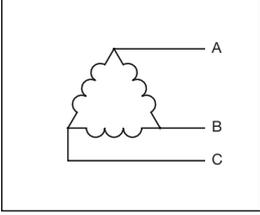
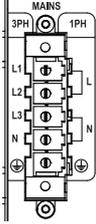
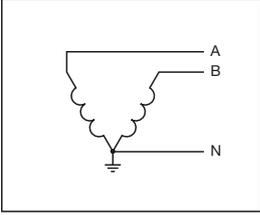
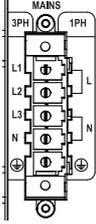
CONNECTION SYSTEM	CABLE WIRING	Q5 CONNECTOR	BREAKER CONNECTION
<p>6</p>  <p>Single-Phase 2-Wire; Grounded Neutral; Contiguous Ground</p>	$L_1 - L_1 // L_2$ $L_2 - L_3 // N$ 		<p>Symbol "L1 // L2" (parallel connection) means connect the pole L1 together with the pole L2. The parallel connection must be done at the breaker output and not at the connector level. Symbol "n.c." means not connected.</p>
<p>7</p>  <p>3-Phase Wye: 3-Wire.</p>	$A - L_1$ $B - L_2$ $C - L_3$ 		
<p>8</p>  <p>3-Phase Wye: 3-Wire; Grounded Neutral Point.</p>	$A - L_1$ $B - L_2$ $C - L_3$ 		
<p>9</p>  <p>3-Phase Wye: 4-Wire; Nongrounded Neutral.</p>	$A - L_1$ $B - L_2$ $C - L_3$ $N - N$ 		
<p>10</p>  <p>3-Phase Delta: 3-Wire.</p>	$A - L_1$ $B - L_2$ $C - L_3$ 		
<p>11</p>  <p>3-Phase Delta: 3-Wire; Grounded Junction of Phases.</p>	$A - L_1 // L_2$ $B - L_3 // N$ $N - n.c.$ 		<p>Symbol "L1 // L2" (parallel connection) means connect the pole L1 together with the pole L2. The parallel connection must be done at the breaker output and not at the connector level. Symbol "n.c." means not connected.</p>

Appendix A: Mains wiring options

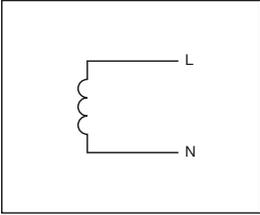
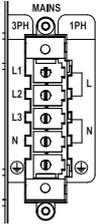
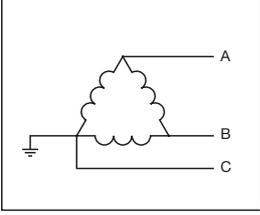
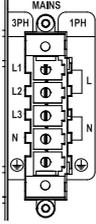
CONNECTION SYSTEM	CABLE WIRING	Q5 CONNECTOR	BREAKER CONNECTION
<div style="border: 1px solid black; padding: 5px; display: inline-block; margin-bottom: 5px;">12</div>  <p data-bbox="193 566 475 607">Single-Phase: 2-Wire; Nongrounded Neutral.</p>	<p data-bbox="504 427 608 479">A - L₁ // L₂ N - L₃ // N</p> 		<p data-bbox="799 412 1445 524">Symbol "L1 // L2" (parallel connection) means connect the pole L1 together with the pole L2. The parallel connection must be done at the breaker output and not at the connector level.</p> <p data-bbox="951 495 1294 524">Symbol "n.c." means not connected.</p>
<div style="border: 1px solid black; padding: 5px; display: inline-block; margin-bottom: 5px;">13</div>  <p data-bbox="248 869 421 891">3-Phase Delta: 3-Wire.</p>	<p data-bbox="528 707 584 792">A - L₁ B - L₂ C - L₃</p> 		

Appendix B: Specifications

Channel Handling	
Number of output channels	4 mono, bridgeable per ch. pair
Number of input channels:	
Analog	4 (4x XLR)
AES3	4 (2x XLR)

Audio	
Output Noise A-Weighted @ 8 Ω - Analog to Analog / Digital to Analog	< -70.0 dBV
Dynamic Range A-Weighted @ 8 Ω - Analog to Analog / Digital to Analog	114,3 dB
Damping Factor @ 8 Ω, 20Hz - 500Hz	> 5000
Slew Rate (input filter bypassed)	> 50 V/μs
Frequency Response (-3 dB, 1 W @ 8 Ω)	5 Hz - 30 kHz
Crosstalk (1 kHz)	-70 dB
THD+N (from 0.1 W to Full Power)	< 0.5% (typical < 0.01%)
DIM (from 0.1 W to Full Power)	< 0.5% (typical < 0.01%)
Input Impedance	20 kΩ Balanced
Input Acceptance	+27 dBu

DSP	
AD converters	24 Bit Tandem™ @ 96 kHz 129 dB Dynamic Range - 0.00056 % THD+N
DA converters	24 Bit Tandem™ @ 192 kHz 121 dB Dynamic Range - 0.00084 % THD+N
Sample rate converter	24 Bit @ 44.1 kHz to 192 kHz 140 dB Dynamic Range - 0.0001 % THD+N
Internal precision	40 bit floating point
Delay	2 s + 100 ms for time alignment
Equalizer	Raised-cosine, custom FIR, parametric IIR: peaking, hi/lo-shelving, all-pass, band-pass, band-stop, hi/lo-pass
Crossover	linear phase (FIR), hybrid (FIR-IIR), Butterworth, Linkwitz-Riley, Bessel: 6 dB/oct to 48 dB/oct (IIR)
Limiters	TruePower™, RMS voltage, RMS current, Peak limiter
Damping control	Active DampingControl™

Construction	
Dimensions	483 mm x 44.5 mm x 495 mm (19.0 in x 1.75 in x 19.5 in)
Weight	15 kg (33.0 lb)

Output Stage	
Maximum output power per channel @ 8 Ω	1600 W
Maximum output power per channel @ 4 Ω	3000 W
Maximum output power per channel @ 2 Ω	5200 W
Maximum output power @ 8 Ω Bridged	6000 W
Maximum output power @ 4 Ω Bridged	10400 W
Peak total output, all channels driven	20000 W
Maximum unclipped output voltage	175 V _{peak}
Maximum output current	130 A _{peak}

The power figure is calculated by driving and loading symmetrically all the channels: uneven loads allow to achieve high performance.

AC Mains Power	
Single-Phase	
Nominal Voltage	100 - 240 V @ 50/60Hz
Operating Range	90 - 264 V from DC to 200Hz
Power Factor 1/8 Maximum Output Power @ 4 Ω	> 0.9
Current Draw 1/8 Maximum Output Power @ 4 Ω	18 A _{rms} @ 100V 9 A _{rms} @ 240V
Suggested circuit breaker	C16

Three-Phase	
Nominal Voltage**	208Y/120 - 416Y/240 V, 3~, 3W+N+PE @ 50/60Hz 200 V~, 3W+PE @ 50/60Hz
Power Factor 1/8 Maximum Output Power @ 4 Ω	> 0.9
Current Drawn from Each Single Phase 1/8 Maximum Output Power @ 4 Ω	6 A _{rms} @ 208Y 3 A _{rms} @ 416Y
Suggested circuit breaker (per phase)	C10

Bi-Phase	
Nominal Voltage	200/100 V, 2W+PE @ 50/60Hz
Idle Consumption (all AC MAINS cases)	< 100 W
Max Consumption (all AC MAINS cases)	< 3500 W

** Note: 208Y/120 V = 208 V phase-to-phase, 120 V phase-to-neutral

Thermal	
Operating temperature	0° - 15°C / 32° - 113°F
Cooling	Fan, continuously variable speed, temperature controlled
Thermal dissipation	
Single phase	115V 230V
1/8 Maximum Output Power @ 8 Ω	1127 BTU/h 1058 BTU/h
1/4 Maximum Output Power @ 8 Ω	2124 BTU/h 1639 BTU/h

North America

Void Acoustics North America
503-854-7134
sales.usa@voidacoustics.com

Head Office

Void Acoustics Research Ltd
Unit 15 Dawkins Road Industrial Estate
Poole
Dorset
BH15 4JY
England

+44 (0) 1202 666 006
info@voidacoustics.com

Registered in England & Wales No. 07533536

www.voidacoustics.com

